

SPECIFICATION

Device Name : IGBT _____

Type Name : FGW50N60H _____

DWG. No. : MS5F07677 _____

Date : Nov.-19-2010 _____

This material and the information herein is the property of Fuji Electric Co., Ltd.
 They shall be neither reproduced, copied, lent, or disclosed in any way whatsoever for
 the use of any third party nor used for the manufacturing purposes without the express
 written consent of Fuji Electric Co., Ltd.

REVISIONS	

	DATE	NAME	APPROVED		Fuji Electric Co., Ltd.
DRAWN	Nov./19/'10	<i>Y. Hara</i>	<i>n. Fujikawa</i>	DWG. NO.	MS5F07677 1/15
CHECKED	Nov./19/'10	<i>A. Kitamura</i>			
CHECKED	Nov./19/'10	<i>O. Yamada</i>			

Revised Records

Date	Classification	Index	Content	Drawn	Checked	Checked	Approved
Nov.19 2010	enactment	---	-----	---	<i>A. Kitamura</i>	<i>O. Tamaki</i>	<i>N. Fujikura</i>

This material and the information herein is the property of Fuji Electric Co., Ltd.
 They shall be neither reproduced, copied, lent, or disclosed in any way whatsoever for
 the use of any third party nor used for the manufacturing purposes without the express
 written consent of Fuji Electric Co., Ltd.

Fuji Electric Co., Ltd.

DWG.NO.

MS5F07677

2/15

This material and the information herein is the property of Fuji Electric Co., Ltd.
 They shall be neither reproduced, copied, lent, or disclosed in any way whatsoever for
 the use of any third party nor used for the manufacturing purposes without the express
 written consent of Fuji Electric Co., Ltd.

- 1.Scope:** This specifies Fuji Discrete IGBT "FGW50N60H"
- 2.Construction:** IGBT in Trench gate Field stop technology
- 3.Applications:** Uninterrupted Power Supply
PV Power Conditioner
Inverter welding machine
- 4.Package:** TO-247 (See to 9/15 page)
- 5.Packing:** Plastic tube
- 6.Equivalent circuit**

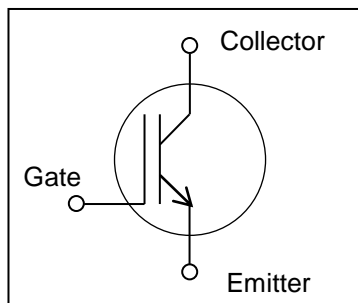

7.Absolute Maximum Ratings at Tj=25°C (unless otherwise specified)

Items	Symbol	Characteristics	Unit	Remarks
Collector-Emitter Voltage	V_{CES}	600	V	
Gate-Emitter Voltage	V_{GES}	± 20	V	
DC Collector Current	$I_{C@25}$	95	A	$T_c=25^\circ\text{C}, T_j=150^\circ\text{C}$
	$I_{C@100}$	50	A	$T_c=100^\circ\text{C}, T_j=150^\circ\text{C}$
Pulsed Collector Current	I_{CP}	150	A	Note *1
Turn-Off Safe Operating Area	-	150	A	$V_{ce} \leq 600\text{V}, T_j \leq 175^\circ\text{C}$
Short Circuit Withstand Time	t_{SC}	5	μs	$V_{cc} \leq 300\text{V}, V_{GE} = 12\text{V}$ $T_j \leq 150^\circ\text{C}$
Maximum Power Dissipation	P_D	360	W	$T_c=25^\circ\text{C}$
Operating Junction Temperature	T_j	-40 ~ +175	$^\circ\text{C}$	
Storage Temperature	T_{stg}	-55 ~ +175	$^\circ\text{C}$	

Note

*1 : Pulse width limited by T_{jmax} .

8.Electrical Characteristics at Tj=25°C (unless otherwise specified)

Static Characteristics

Description	Symbol	Conditions	min.	typ.	max.	Unit	
Collector-Emitter Breakdown Voltage	$V_{(BR)CES}$	$I_C = 250\mu\text{A}$ $V_{GE} = 0\text{V}$	600	-	-	V	
Zero Gate Voltage Collector Current	I_{CES}	$V_{CE} = 600\text{V}$ $V_{GE} = 0\text{V}$	$T_j=25^\circ\text{C}$	-	250	μA	
			$T_j=175^\circ\text{C}$	-	10	mA	
Gate-Emitter Leakage Current	I_{GES}	$V_{CE} = 0\text{V}$ $V_{GE} = \pm 20\text{V}$	-	-	200	nA	
Gate-Emitter Threshold Voltage	$V_{GE(th)}$	$V_{CE} = +20\text{V}$ $I_C = 50\text{mA}$	4.0	5.0	6.0	V	
Collector-Emitter Saturation Voltage	$V_{CE(sat)}$	$V_{GE} = +15\text{V}$ $I_C = 50\text{A}$	$T_j=25^\circ\text{C}$	-	1.50	1.95	V
			$T_j=175^\circ\text{C}$	-	1.80	-	

Fuji Electric Co., Ltd.

DWG.NO.

MS5F07677

3/15

Dynamic Characteristics

Description	Symbol	Conditions	min.	typ.	max.	Unit
Input Capacitance	Cies	$V_{CE}=25V$ $V_{GE}=0V$ $f=1MHz$	-	4320	-	pF
Output Capacitance	Coes		-	210	-	
Reverse Transfer Capacitance	Cres		-	160	-	
Gate Charge	Q_G	$V_{CC} = 400V$ $I_C = 50A$ $V_{GE} = 15V$	-	305	-	nC
Turn-On Delay Time	td(on)	$T_J = 25^\circ C$ $V_{CC} = 400V$ $I_C = 50A$ $V_{GE} = 15V$ $R_G = 10\Omega$ $L = 500\mu H$ Energy loss include "tail" and FWD(FDRW25S60L) reverse recovery.	-	35	-	ns
Rise Time	tr		-	75	-	
Turn-Off Delay Time	td(off)		-	310	-	
Fall Time	tf		-	60	-	
Turn-On Energy	Eon		-	1.4	-	mJ
Turn-Off Energy	Eoff		-	1.7	-	
Turn-On Delay Time	td(on)	$T_J = 175^\circ C$ $V_{CC} = 400V$ $I_C = 50A$ $V_{GE} = 15V$ $R_G = 10\Omega$ $L = 500\mu H$ Energy loss include "tail" and FWD(FDRW25S60L) reverse recovery.	-	40	-	ns
Rise Time	tr		-	85	-	
Turn-Off Delay Time	td(off)		-	335	-	
Fall Time	tf		-	72	-	
Turn-On Energy	Eon		-	2.4	-	mJ
Turn-Off Energy	Eoff		-	2.2	-	

9. Thermal Resistance

Description	Symbol	min.	typ.	max.	Unit
Thermal Resistance, Junction-Ambient	Rth(j-a)	-	-	50	$^\circ C/W$
Thermal Resistance, Junction to Case	Rth(j-c)	-	-	0.417	$^\circ C/W$

This material and the information herein is the property of Fuji Electric Co., Ltd.
 They shall be neither reproduced, copied, lent, or disclosed in any way whatsoever for
 the use of any third party nor used for the manufacturing purposes without the express
 written consent of Fuji Electric Co., Ltd.

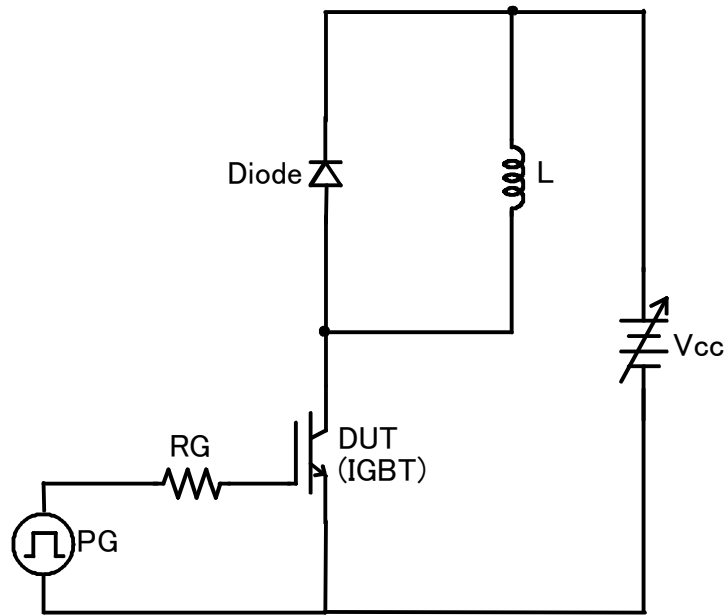

Fig.1 : Switching test circuit

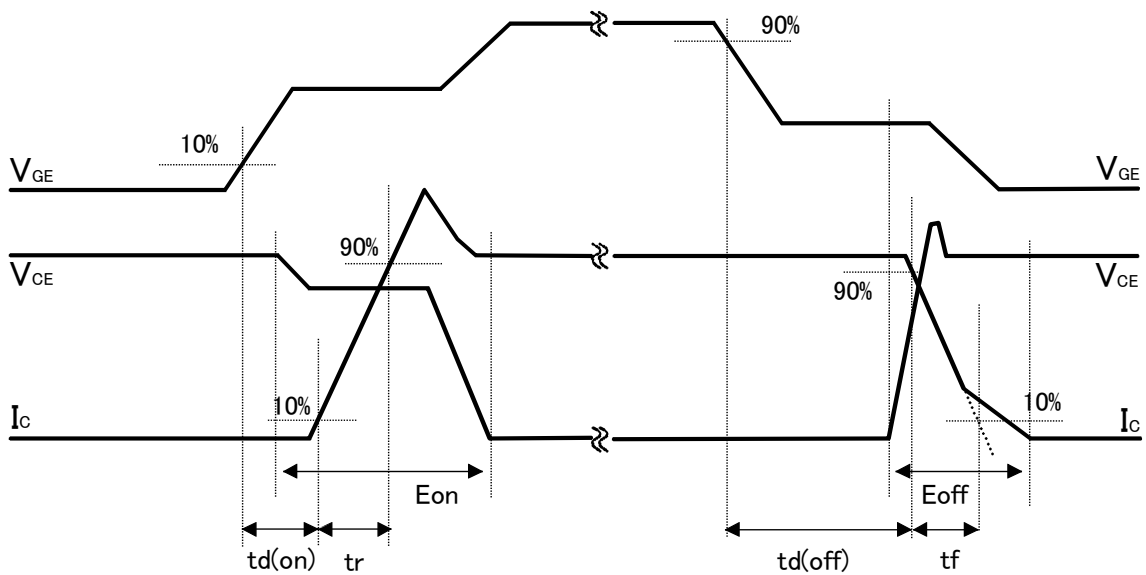
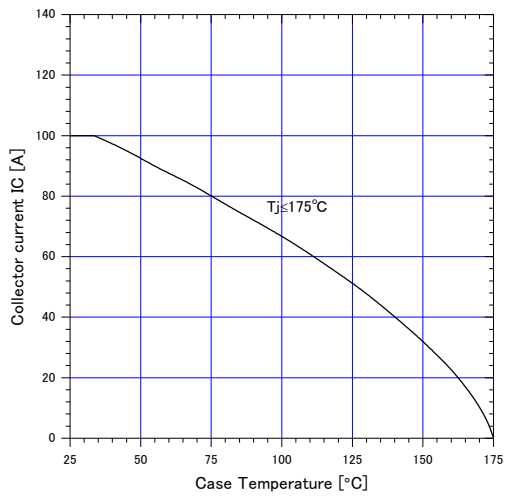

Fig.2 : Switching waveforms

This material and the information herein is the property of Fuji Electric Co., Ltd.
 They shall be neither reproduced, copied, lent, or disclosed in any way whatsoever for
 the use of any third party nor used for the manufacturing purposes without the express
 written consent of Fuji Electric Co., Ltd.

Graph.1
 DC Collector Current vs Tc
 $V_{GE} \geq +15V, T_j \leq 175^\circ C$



Graph.2
 Collector Current vs. switching frequency
 $V_{GE} = +15V, T_c \leq 175^\circ C, V_{CC} = 400V, D = 0.5,$
 $R_G = 10\Omega, T_C = 100^\circ C$

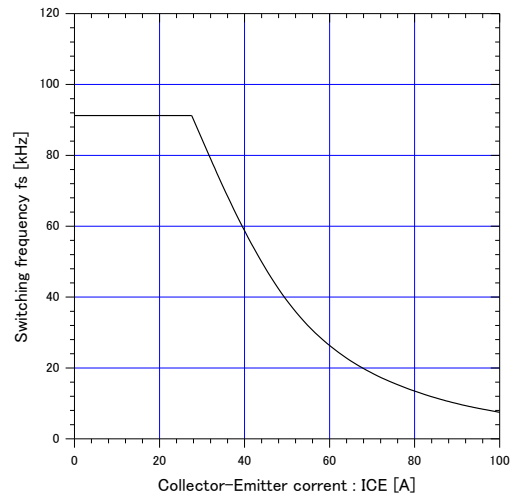

Graph.3
 Typical Output Characteristics (VCE-IC)
 $T_j = 25^\circ C$

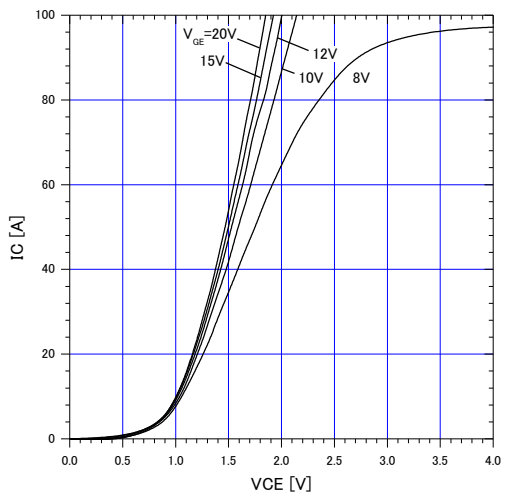

Graph.4
 Typical Output Characteristics (VCE-IC)
 $T_j = 175^\circ C$

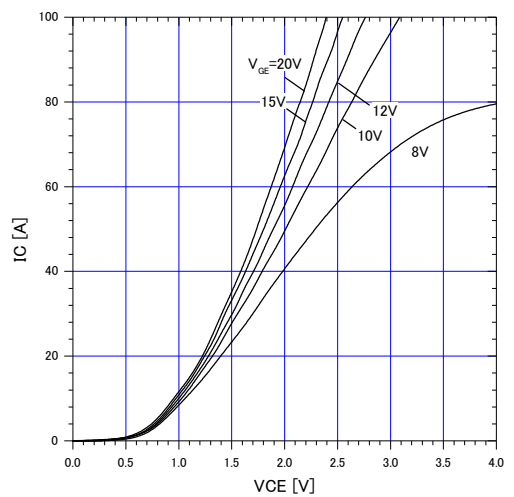

Graph.5
 Typical Transfer Characteristics
 $V_{GE} = +15V$

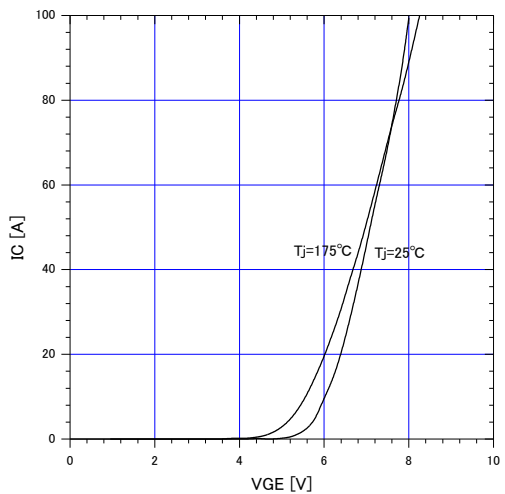

Graph.6
 Gate Threshold Voltage vs. Tj
 $I_C = 50mA, V_{CE} = 20V$

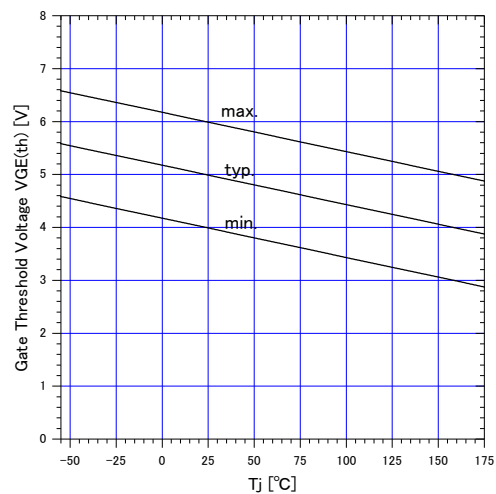

This material and the information herein is the property of Fuji Electric Co., Ltd.
 They shall be neither reproduced, copied, lent, or disclosed in any way whatsoever for
 the use of any third party nor used for the manufacturing purposes without the express
 written consent of Fuji Electric Co., Ltd.

Graph.7
 Typical Capacitance
 $V_{GE}=0V, f=1MHz, T_j=25^\circ C$

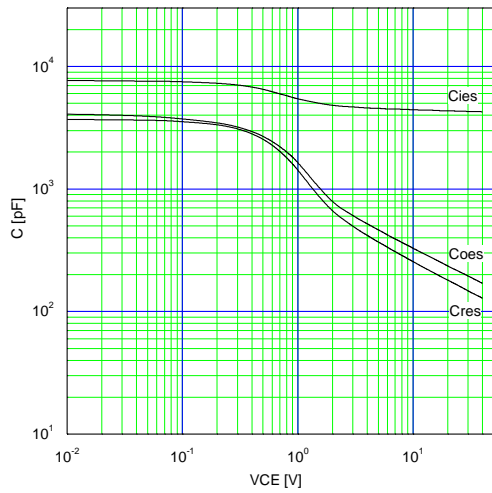

Graph.8
 Typical Gate Charge
 $V_{CC}=400V, I_C=50A, T_j=25^\circ C$

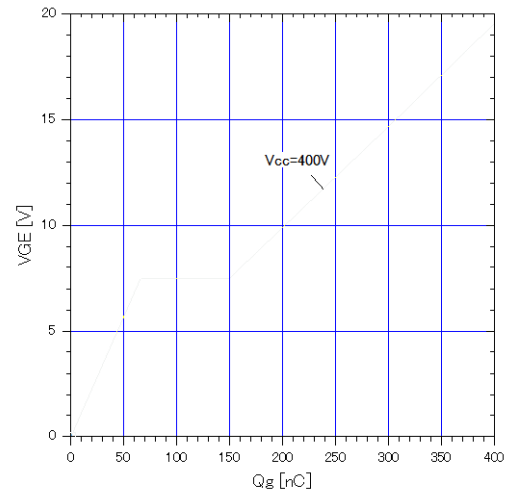

Graph.9
 Typical switching time vs. I_C
 $T_j=175^\circ C, V_{CC}=400V, L=500\mu H$
 $V_{GE}=15V, R_G=10\Omega$

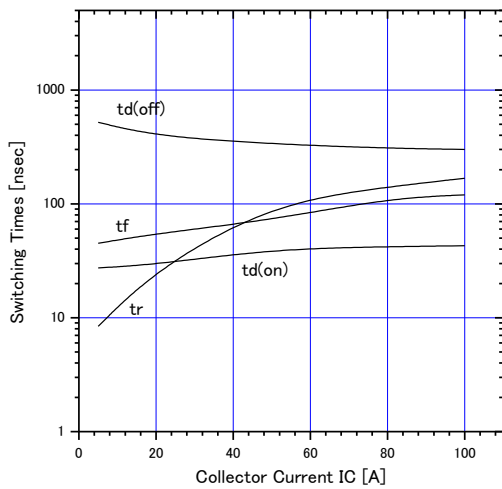

Graph.10
 Typical switching time vs. R_G
 $T_j=175^\circ C, V_{CC}=400V, I_C=50A, L=500\mu H$
 $V_{GE}=15V$

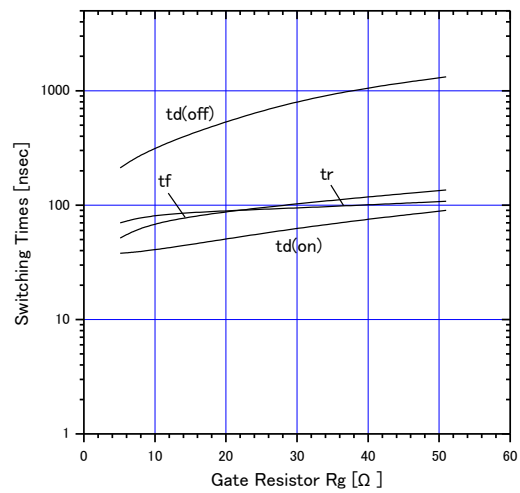

Graph.11
 Typical switching losses vs. I_C
 $T_j=175^\circ C, V_{CC}=400V, L=500\mu H$
 $V_{GE}=15V, R_G=10\Omega$

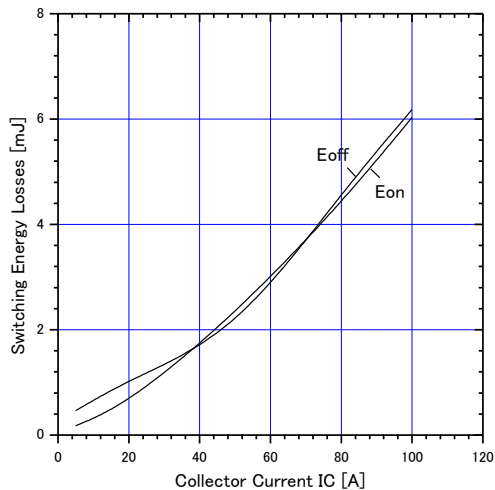

Graph.12
 Typical switching losses vs. R_G
 $T_j=175^\circ C, V_{CC}=400V, I_C=50A, L=500\mu H$
 $V_{GE}=15V$

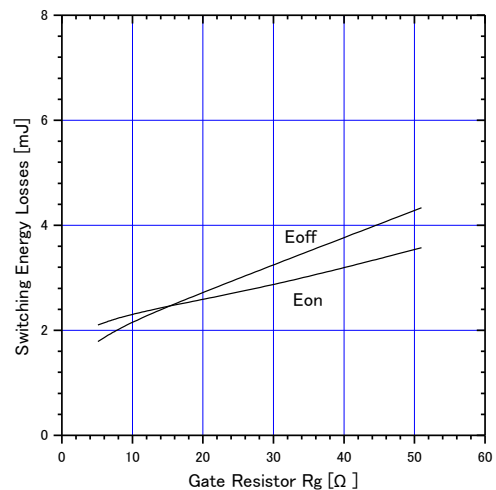

This material and the information herein is the property of Fuji Electric Co., Ltd.
 They shall be neither reproduced, copied, lent, or disclosed in any way whatsoever for
 the use of any third party nor used for the manufacturing purposes without the express
 written consent of Fuji Electric Co., Ltd.

Graph.13
 Reverse biased Safe Operating Area
 $T_j \leq 175^\circ\text{C}, V_{GE} = +15\text{V}/0\text{V}, R_G = 10\Omega$

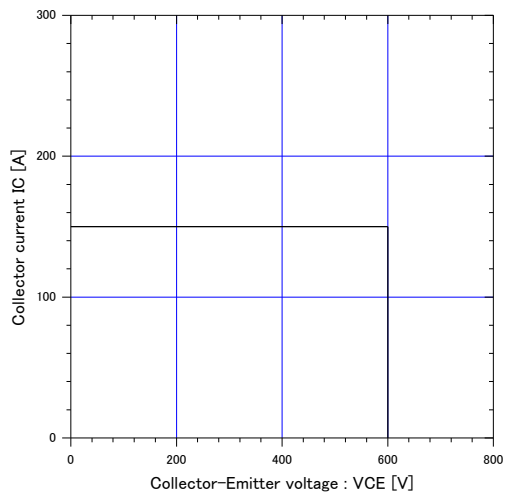

Graph.14
 Transient thermal resistance of IGBT

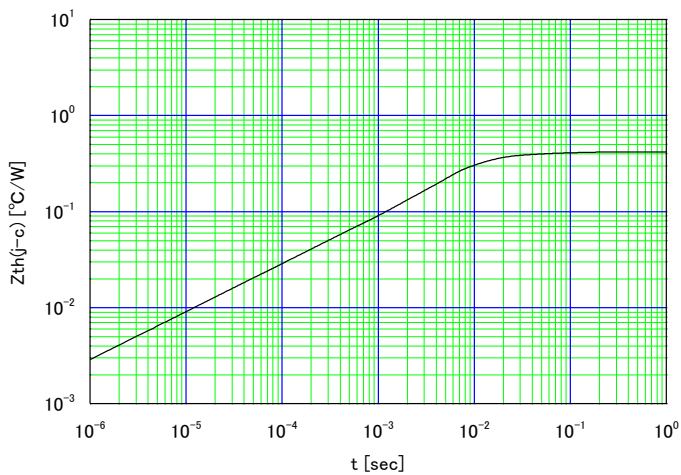

This material and the information herein is the property of Fuji Electric Co., Ltd.
 They shall be neither reproduced, copied, lent, or disclosed in any way whatsoever for
 the use of any third party nor used for the manufacturing purposes without the express
 written consent of Fuji Electric Co., Ltd.

Outview : TO-247 Package

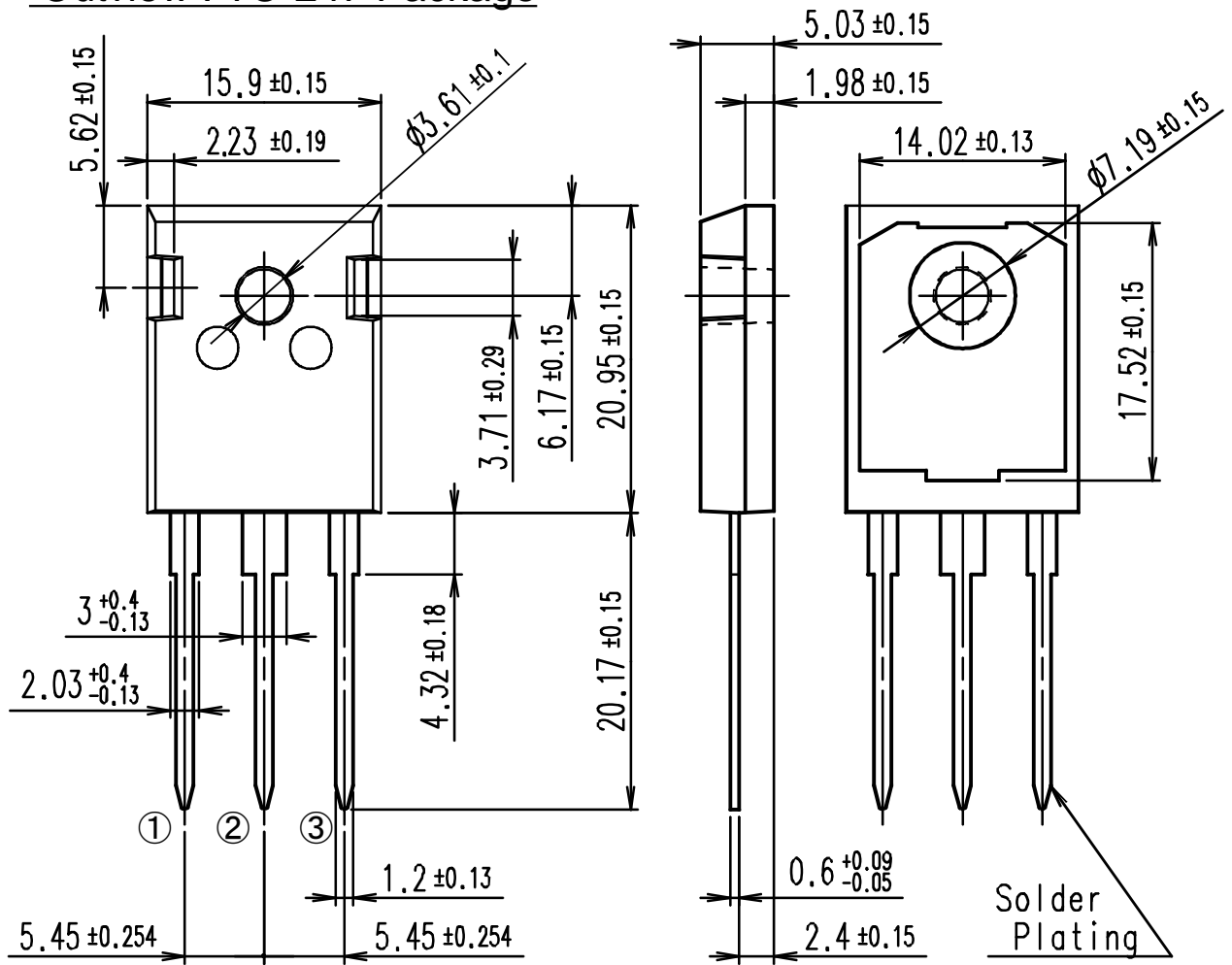

CONNECTION

- ① GATE
- ② COLLECTOR
- ③ EMITTER

DIMENSIONS ARE IN MILLIMETERS.

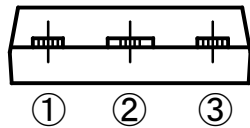

MARKING

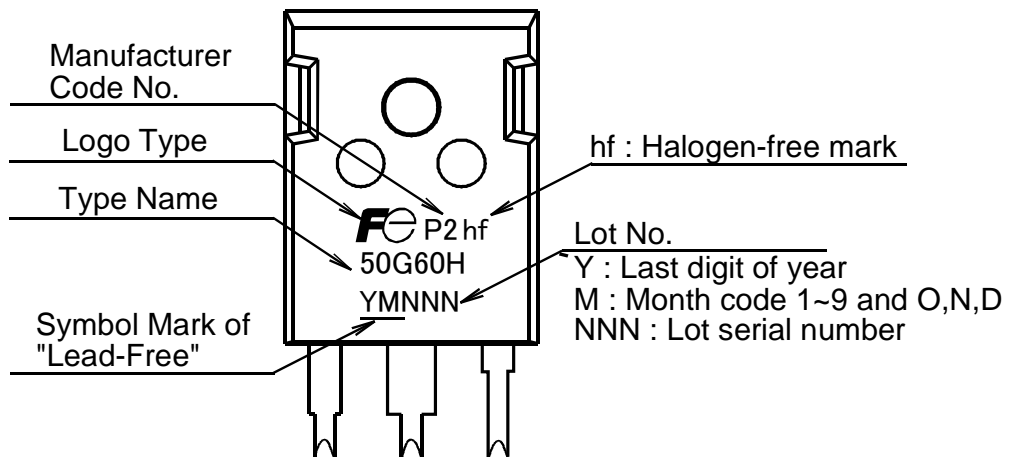

* The font (font type,size) and the logo type size might be actually different.

Fuji Electric Co., Ltd.

DWG.NO.

MS5F07677

9/15

H04-004-03

10. Reliability test items

All guaranteed values are under the categories of reliability per non-assembled (only IGBTs).
 Each categories under the guaranteed reliability conform to EIAJ ED4701/100 method104 standards.

(Test items required without fail
 Humidification treatment ($85 \pm 2^\circ\text{C}$, $65 \pm 5\% \text{RH}$, $168 \pm 24 \text{hr}$)
 Heat treatment of soldering (Solder Dipping, $260 \pm 5^\circ\text{C}$ (265°Cmax.), $10 \pm 1 \text{sec}$, 2 times))

	Test No.	Test Items	Testing methods and Conditions	Reference Standard	Sampling number	Acceptance number
Mechanical test methods	1	Terminal Strength (Tensile)	Pull force TO-247 : 25N Force maintaining duration : $30 \pm 5 \text{sec}$	EIAJ ED4701/400 method 401	15	(0:1)
	2	Terminal Strength (Bending)	Load force TO-247 : 10N Number of times : 2times(90deg./time)	EIAJ ED4701/400 method 401	15	
	3	Mounting Strength	Screwing torque value: (M3) TO-247 : $50 \pm 10 \text{N} \cdot \text{cm}$	EIAJ ED4701/400 method 402	15	
	4	Vibration	frequency : 100Hz to 2kHz Acceleration : 200m/s^2 Sweeping time : 4min. 48min. for each X,Y&Z directions.	EIAJ ED4701/400 method 403	15	
	5	Shock	Peak amplitude: 15km/s^2 Duration time : 0.5ms 3times for each X,Y&Z directions.	EIAJ ED4701/400 method 404	15	
	6	Solderability	Solder temp. : $245 \pm 5^\circ\text{C}$ Immersion time : $5 \pm 0.5 \text{sec}$ Each terminal shall be immersed in the solder bath within 1 to 1.5mm from the body. Solder alloy: Sn-Ag-Cu type	-----	15	
	7	Resistance to Soldering Heat	Solder temp. : $260 \pm 5^\circ\text{C}$ Immersion time : $10 \pm 1 \text{sec}$ Number of times : 1times Solder alloy: Sn-Ag-Cu type	EIAJ ED4701/300 method 302	15	

This material and the information herein is the property of Fuji Electric Co., Ltd.
 They shall be neither reproduced, copied, lent, or disclosed in any way whatsoever for the use of any third party nor used for the manufacturing purposes without the express written consent of Fuji Electric Co., Ltd.

This material and the information herein is the property of Fuji Electric Co., Ltd.
 They shall be neither reproduced, copied, lent, or disclosed in any way whatsoever for
 the use of any third party nor used for the manufacturing purposes without the express
 written consent of Fuji Electric Co., Ltd.

	Test No.	Test Items	Testing methods and Conditions	Reference Standard	Sampling number	Acceptance number
Climatic test methods	1	High Temp. Storage	Temperature : 175+0/-5°C Test duration : 1000hr	EIAJ ED4701/200 method 201	22	(0:1)
	2	Low Temp. Storage	Temperature : -55+5/-0°C Test duration : 1000hr	EIAJ ED4701/200 method 202	22	
	3	Temperature Humidity Storage	Temperature : 85±2°C Relative humidity : 85±5% Test duration : 1000hr	EIAJ ED4701/100 method 103	22	
	4	Temperature Humidity BIAS	Temperature : 85±2°C Relative humidity : 85±5% Bias Voltage : $V_{CE(max)} * 0.8$ Test duration : 1000hr	EIAJ ED4701/100 method 103	22	
	5	Unsaturated Pressurized Vapor	Temperature : 130±2°C Relative humidity : 85±5% Vapor pressure : 230kPa Test duration : 48hr	EIAJ ED4701/100 method 103	22	
	6	Temperature Cycle	High temp.side : 175±5°C/30min. Low temp.side : -55±5°C/30min. RT : 5°C ~ 35°C/5min. Number of cycles : 100cycles	EIAJ ED4701/100 method 105	22	
	7	Thermal Shock	Fluid : pure water(running water) High temp.side : 100+0/-5°C Low temp.side : 0+5/-0°C Duration time : HT 5min,LT 5min Number of cycles : 100cycles	EIAJ ED4701/300 method 307	22	
Endurance test methods	8	Intermittent Operating Life	$\Delta T_c=90$ degree $T_j \leq T_j(max.)$ Test duration : 3000 cycle	EIAJ ED4701/100 method 106	22	(0:1)
	9	HTRB (Gate-Emitter)	Temperature : $T_j=175+0/-5^\circ C$ Bias Voltage : $+V_{GE(max)}$ Test duration : 1000hr	EIAJ ED4701/100 method 101	22	
	10	HTRB (Collector-Emitter)	Temperature : $T_j=175+0/-5^\circ C$ Bias Voltage : $V_{CE(max)}*0.8$ Test duration : 1000hr	EIAJ ED4701/100 method 101	22	

Failure Criteria

	Item	Symbols	Failure Criteria		Unit
			Lower Limit	Upper Limit	
Electrical Characteristics	Zero gate Voltage Collector-Emitter Current	ICES	-----	USL	A
	Gate-Emitter Leakage Current	IGES	-----	USL	A
	Gate Threshold Voltage	VGE(th)	LSL	USL	V
	Collector-Emitter saturation Voltage	VCE(sat)	-----	USL	V
Outview	Marking, Soldering and other damages	-----	With eyes or Microscope		-----

* LSL : Lower Specification Limit * USL : Upper Specification Limit

* Before any of electrical characteristics measure, all testing related to the humidity have conducted after drying the package surface for more than an hour at 150°C

Fuji Electric Co., Ltd.

DWG.NO.

MS5F07677

11/15

11. Cautions

- Although Fuji Electric is continually improving product quality and reliability, a small percentage of semiconductor products may become faulty. When using Fuji Electric semiconductor products in your equipment, you are requested to take adequate safety measures to prevent the equipment from causing physical injury, fire, or other problem in case any of the products fail. It is recommended to make your design fail-safe, flame retardant, and free of malfunction.
- The products described in this Specification are intended for use in the following electronic and electrical equipment which has normal reliability requirements.
 - Computers · OA equipment · Communications equipment (Terminal devices)
 - Machine tools · AV equipment · Measurement equipment
 - Personal equipment · Industrial robots · Electrical home appliances etc.
- The products described in this Specification are not designed or manufactured to be used in equipment or systems used under life-threatening situations. If you are considering using these products in the equipment listed below, first check the system construction and required reliability, and take adequate safety measures such as a backup system to prevent the equipment from malfunctioning.
 - Backbone network equipment · Transportation equipment (automobiles, trains, ships, etc.)
 - Traffic-signal control equipment · Gas alarms, leakage gas auto breakers
 - Submarine repeater equipment · Burglar alarms, fire alarms, emergency equipment
 - Medical equipment · Nuclear control equipment etc.
- Do not use the products in this Specification for equipment requiring strict reliability such as (but not limited to):
 - Aerospace equipment · Aeronautical equipment

12. Warnings

- The IGBTs should be used in products within their absolute maximum rating (voltage, current, temperature, etc.).
- The IGBTs may be destroyed if used beyond the rating.
- It shall be confirmed that IGBT's operating locus of the turn-off voltage and current are within the RBSOA specification. This product may be broken if the locus is out of the RBSOA..
- This product may be broken by avalanche in case of VCE beyond maximum rating VCES is applied between C-E terminals. Use this product within its maximum
- The equipment containing IGBTs should have adequate fuses or circuit breakers to prevent the equipment from causing secondary destruction (ex. fire, explosion etc...).
- Use the IGBTs within their reliability and lifetime under certain environments or conditions. The IGBTs may fail before the target lifetime of your products if used under certain reliability conditions.
- Be careful when handling IGBTs for ESD damage. (It is an important consideration.)
- When handling IGBTs, hold them by the case (package) and don't touch the leads and terminals.
- It is recommended that any handling of IGBTs is done on grounded electrically conductive floor and tablemats.

- Before touching a IGBT terminal, Discharge any static electricity from your body and clothes by grounding out through a high impedance resistor (about 1MΩ)
- When soldering, in order to protect the IGBTs from static electricity, ground the soldering iron or soldering bath through a low impedance resistor.
- You must design the IGBTs to be operated within the specified maximum ratings (voltage, current, temperature, etc.) to prevent possible failure or destruction of devices.
- Consider the possible temperature rise not only for the junction and case, but also for the outer leads.
- Do not directly touch the leads or package of the IGBTs while power is supplied or during operation in order to avoid electric shock and burns.
- The IGBTs are made of incombustible material. However, if a IGBT fails, it may emit smoke or flame. Also, operating the IGBTs near any flammable place or material may cause the IGBTs to emit smoke or flame in case the IGBTs become even hotter during operation. Design the arrangement to prevent the spread of fire.
- The IGBTs should not used in an environment in the presence of acid, organic matter, or corrosive gas (hydrogen sulfide, sulfurous acid gas etc.)
- The IGBTs should not used in an irradiated environment since they are not radiation-proof.

Installation

- Soldering involves temperatures which exceed the device storage temperature rating. To avoid device damage and to ensure reliability, observe the following guidelines from the quality assurance standard.

Soldering methods

Packages		Soldering Methods				
		Wave Soldering (Full dipping)	Wave Soldering (Only terminal)	Infrared Reflow	Air Reflow	Soldering iron (Re-work)
Through hole package	TO-220	U	P	U	U	P1
	TO-220F	U	P	U	U	P1
	TO-3P	U	P	U	U	P1
	TO-3PF	U	P	U	U	P1
	TO-247	U	P	U	U	P1
	TO-3P	U	P	U	U	P1

P: Possible P1: Possible (Only 1 time) P2: Possible (Only 2 times) U: Unable

Solder temperature and duration

Package type	Methods	Soldering Temp. & Time	Note
Through hole package	A	Solder dipping Soldering iron	260±5°C, 10±1sec
	B	Solder dipping Soldering iron	350±10°C, 3.5±0.5sec

- The immersion depth of the lead should basically be up to the lead stopper and the distance should be a maximum of 1.5mm from the device.
- When flow-soldering, be careful to avoid immersing the package in the solder bath.
- Refer to the following torque reference when mounting the device on a heat sink. Excess torque applied to the mounting screw causes damage to the device and weak torque will increase the thermal resistance, both of which conditions may destroy the device.

Table 1: Recommended tightening torques. (Through hole package)

Package style	Screw	Tightening torques	Note
TO-220 TO-220F	M3	30 – 50 Ncm	flatness : $\leq \pm 30\mu\text{m}$ roughness : $\leq 10\mu\text{m}$ Plane off the edges : $C \leq 1.0\text{mm}$
TO-3P TO-3PF TO-247	M3	40 – 60 Ncm	
TO-3PL	M3	60 – 80 Ncm	

- The heat sink should have a flatness within $\pm 30\mu\text{m}$ and roughness within $10\mu\text{m}$. Also, keep the tightening torque within the limits of this specification.
- Improper handling may cause isolation breakdown leading to a critical accident.
ex.) Over plane off the edges of screw hole. (Recommended plane off the edge is $C < 1.0\text{mm}$)
- We recommend the use of thermal compound to optimize the efficiency of heat radiation. It is important to evenly apply the compound and to eliminate any air voids.

Storage

- The IGBTs must be stored at a standard temperature of 5 to 35°C and relative humidity of 45 to 75%.
- If the storage area is very dry, a humidifier may be required. In such a case, use only deionized water or boiled water, since the chlorine in tap water may corrode the leads.
- The IGBTs should not be subjected to rapid changes in temperature to avoid condensation on the surface of the IGBTs. Therefore store the IGBTs in a place where the temperature is steady.
- The IGBTs should not be stored on top of each other, since this may cause excessive external force on the case.
- The IGBTs should be stored with the lead terminals remaining unprocessed. Rust may cause presoldered connections to fail during later processing.
- The IGBTs should be stored in antistatic containers or shipping bags.

This material and the information herein is the property of Fuji Electric Co., Ltd. They shall be neither reproduced, copied, lent, or disclosed in any way whatsoever for the use of any third party nor used for the manufacturing purposes without the express written consent of Fuji Electric Co., Ltd.

13) Compliance with pertaining to restricted substances

13-1) Compliance with the RoHS Regulations

This product will be fully compliant with the RoHS directive.

All of six substances below which are regulated by the RoHS directive in Europe are not included in this product.

* The six substances regulated by the RoHS Directive are:

Lead, Mercury, Hexavalent chromium, Cadmium, PBB (polybrominated biphenyls),
PBDE (polybrominated diphenyl ethers).

13-2) Compliance with the class-1 ODS and class-2 ODS. (ODS: Ozone-Depleting Substances)

This products does not contain and used the "Law concerning the Protection of the Ozone Layer through the Control of Specified Substances and Other Measures (JAPAN)", and the Montreal Protocol.

- If you have any questions about any part of this Specification, please contact Fuji Electric or its sales agent before using the product.
- Neither Fuji nor its agents shall be held liable for any injury caused by using the products not in accordance with the instructions.
- The application examples described in this specification are merely typical uses of Fuji Electric products.
- This specification does not confer any industrial property rights or other rights, nor constitute a license for such rights.

This material and the information herein is the property of Fuji Electric Co., Ltd.
They shall be neither reproduced, copied, lent, or disclosed in any way whatsoever for
the use of any third party nor used for the manufacturing purposes without the express
written consent of Fuji Electric Co., Ltd.